



**METAL TRADE COMAX, a.s.**



## **PRE-PAINTING / PRÉLAQUAGE EN CONTINU FILM LAMINATION / PRODUITS PLASTIFIÉS**



**AL & HDG Coils  
AL & HDG Bobines**



- plus**
- **CUTTING TO SHEETS**
  - **SLITTING TO STRIPS**
  - **EMBOSSING**
  - **PROTECTIVE FOIL**

- plus**
- **DÉCOUPE TRANSVERSALE**
  - **DÉCOUPE LONGITUDINALE**
  - **STUCCO**
  - **FILM PROTECTEUR AMOVIBLE**



### Parameters of input coils / Paramètres des bobines d'entrée

Input material Matériel de base	Thickness Épaisseur	Width Largeur	Inside diameter Diamètre intérieur	Max. weight Poids maximal	Minimum order Commande minimale
Al & Al - Alloys / Alliages EN AW 1050:3"series:5754	0,40 - 1,50 mm	600 - 1 250 mm	500 / 600 mm	3 500 kg	700 - 1 000 kg
FeZn (HDG) & Fe DX51 - D53; S220 - S350	0,30 - 1,20 mm	600 - 1 335 mm	500 / 600 mm	8 500 kg	1 500 - 2 000 kg

### Composition of pre-painted metal / Composition du matériel prélaqué

#### Single-sided / Mono face

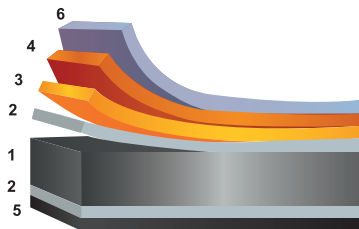

- Single-layer / Mono couche
- Double-layer / Double couche
- Three-layer / Triple couche

- 1 Base material / Matériel de base
- 2 Chemical Pre-treatment / Pré - traitement chimique
- 3 Primer / Primaire
- 3\* Primer / Primaire
- 4 Top coat / Coté recto
- 4\* Back coat / Coté verso
- 5 Protective Paint / Vernis de protection
- 6 Protective peel-off foil / Film protecteur amovible

#### Double-sided / Double face

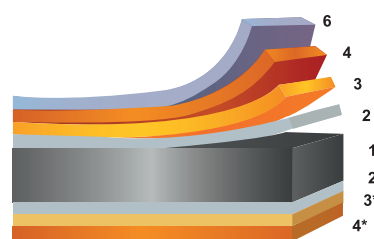

Types of coatings Types de laquage	Thickness Épaisseur (µm)	Coating system Système de laquage	Double-side coating Double face laquage	Protective function of the paint (yrs) Fonction de protection de laquage (années)	Corrosion resistance Résistance à la corrosion
Polyester HD	18 - 25	Single / Double-layer Mono / Double couche	✓	10	RUV 3
Polyester 50	40 - 50	Double / Three-layer Double / Triple couche	✓	12	RUV 4
Polyester TXT	25 - 35	Double-layer Double couche	✗	10	RUV 3
PVDF	25 - 35	Double / Three-layer Double / Triple couche	✓	15	RUV 4
PUR	25 - 45	Double / Three-layer Double / Triple couche	✓	15	RUV 4
PUR / PA	45 - 55	Double / Three-layer Double / Triple couche	✗	20	RUV 4
Back coat Coté verso	3 - 15	White-grey color (FeZn, suitable for PUR foam), green-gold colour (Al), pigment colour. Couleur blanc-gris (FeZn, convenable pour la mousse de PUR), couleur vert-or (Al), pigment couleur	✓	1	RUV 2

### Protective properties of paints / Revêtements selon ses propriétés protectrices

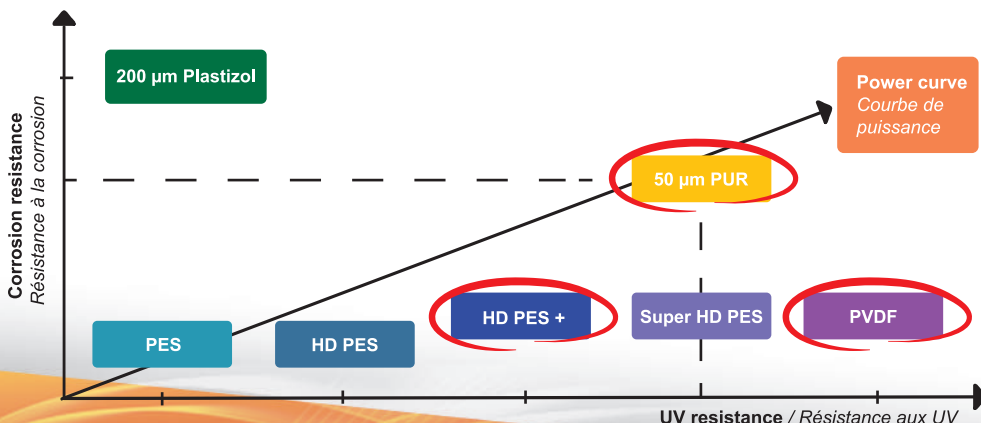

**Note:**

Standard kind of paint supplied by METAL TRADE COMAX, a.s.

**Note:**

Type standard de revêtement fourni METAL TRADE COMAX, a.s.



• **Laminate / Produits plastifiés**

• **PVC - exterior use / PVC - application extérieure**

Wood decors / Décors de bois



Golden Oak



Dark Oak



Nature Oak



Hickory Nutwood



Striped Oak Choco



Japan Cherry

• **PVC - interior us / PVC - application intérieure**

Food safe (FDS) & antibacterial film (AB) / Films alimentaires (FDS) & antibactériens (AB)



9010 FDS



9003 FDS

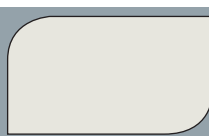

9002 FDS



9001 FDS



9016 AB

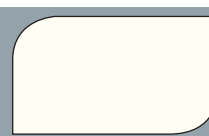

9010 AB

• **Composition & parameters of the laminated bands / Composition & paramètres du produit plastifié**

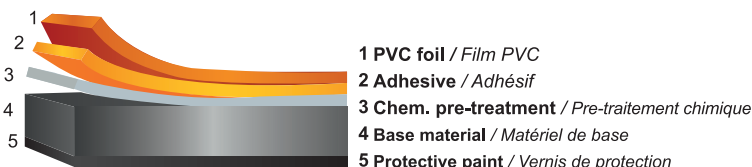

PVC foil PVC film	Thickness Épaisseur (µm)	Corrosion resistance Résistance à la corrosion (years / années)	Protective foil Protecteur amovible
Exterior use Application extérieure	120 - 200	10	✓
Interior use Application intérieure	150	5	✓

• **Processing of pre-painted bands / Traitement des bobines prélaquées**

**1. Cutting to sheets / Découpe transversale**

Thickness (Al): 0,3 - 4,0 mm.  
 Thickness (FeZn): 0,3 - 1,5 mm.  
 Input width: 300 - 1 550 mm.  
 Length of sheets: 300 - 6 000 mm.

Épaisseur (Al): 0,3 - 4,0 mm.  
 Épaisseur (FeZn): 0,3 - 1,5 mm.  
 Largeur d'entrée: 300 - 1 550 mm.  
 Longueur de la feuille: 300 - 6 000 mm.



**2. Slitting to strips / Découpe longitudinale**

Thickness (Al): 0,3 - 1,5 mm.  
 Thickness (FeZn): 0,3 - 1,2 mm.  
 Input width: 150 - 1 260 mm.  
 Min. width of strip: 18 mm.  
 Internal diameter: 500 - 600 mm.  
 Welding possible at bands of width 0,4 - 1,2 mm.

Épaisseur (Al): 0,3 - 1,5 mm.  
 Épaisseur (FeZn): 0,3 - 1,2 mm.  
 Largeur d'entree: 150 - 1 260 mm,  
 Largeur minimale d'un feuillard: 18 mm.  
 Longueur de la feuille: 500 - 600 mm.  
 Soudage possible des bobines FeZn de 0,4 - 1,2 mm.



**3. Embossing / Stucco**

Thickness (Al): 0,4 - 1,4 mm.  
 Thickness (FeZn): 0,4 - 1,2 mm.

Épaisseur (Al): 0,4 - 1,4 mm.  
 Épaisseur (FeZn): 0,4 - 1,2 mm.

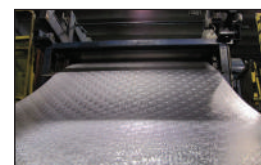

**4. Protective foil / Film protecteur amovible**

Self-adhesive, removable foil, protecting the material from mechanical and aesthetic damage during manipulation and processing.  
 Types: transparent or black & white UV  
 Thickness: 50 - 100 µm

Application d'un film protecteur amovible protège du matériel contre son endommagement esthétique et mécanique pendant sa manipulation.  
 Types: transparent ou noir-blanc UV  
 Épaisseur: 50 - 100 µm



## Headquarters / Siège social:

**METAL TRADE COMAX, a.s.**

273 24, Velvary 420, Czech Republic

GPS: 20°16'53.291"N, 14°14'32.945"E

Tel.: +420 315 730 145, Fax: +420 315 730 224

e-mail: [coating@mtcomax.cz](mailto:coating@mtcomax.cz), [www.mtcomax.cz](http://www.mtcomax.cz)



### • Packing / Emballage

#### • Wooden cradle + PE KI / Berceau en bois + PE KI

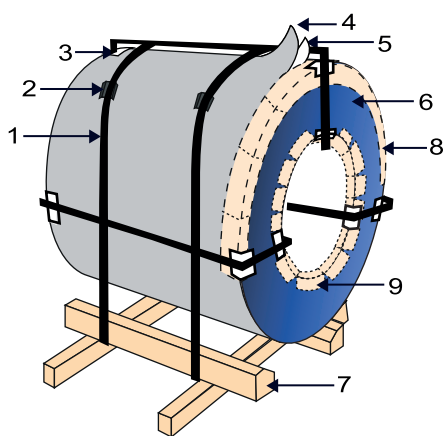

1. Steel strap
2. Steel clip
3. Protective corners\*
4. PE foil / anticorrosion paper
5. Paper
6. Coil
7. Wooden pallet

\*or 8. Outer edge protection  
\*or 9. Inner edge protection

1. Bande d'acier
2. Clip d'acier
3. Coins de protection
4. Feuille de PE / papier anticorrosion
5. Papier
6. Bobine
7. Palette en bois

\*ou 8. Protection de bord extérieur  
\*ou 9. Protection de bord intérieur

#### • Wooden pallet + PE PI / Palette en bois + PE PI

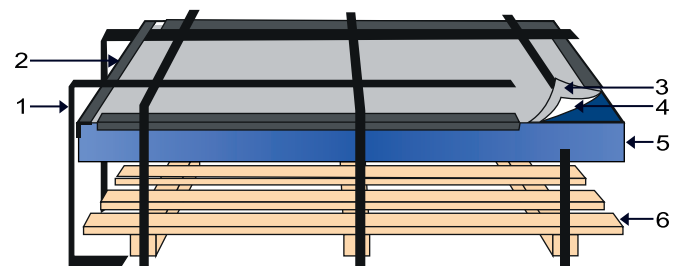

1. Steel strap
2. Protective corner
3. PE foil / anticorrosion paper
4. Paper
5. Metal sheets
6. Wooden pallet

1. Clip d'acier
2. Coins de protection
3. Feuille de PE / papier anticorrosion
4. Papier
5. Feuilles de metal
6. Palette en bois

### • Our strenghts - Your benefit / Nos points forts - Vos avantages

- ✓ Fast delivery term (2 weeks from the order)
- ✓ Option of minimum order (Al from 0,7t, FeZn from 1,5t)
- ✓ A wide range of colours (up to 400 shades)
- ✓ Custom-made colours
- ✓ Customer oriented service

**Délai de livraison rapide (2 semaines dès réception de la commande)**

**Les commandes minimales (de 0,7t Al, de 1,5t FeZn)**

**Une gamme large de couleurs (jusqu'à 400 couleurs)**

**Fabrication des teintes exigées à la demande du client**

**Services orientés sur la clientèle**

### • Products of METAL TRADE COMAX, a.s. in Europe / Produits METAL TRADE COMAX, a.s. in Europe

